

# Showering and Bathing

## AquaMaster Shower and Toileting Chair

The AquaMaster shower and toileting chairs offer a range of standard options, with static, self propelling and attendant propelled models.

### **Flexible**

Starting with the one piece rigid frame, the chair is easily specified, with flexible options available on chair width and height, seat type, backrest, footrests and with a comprehensive range of accessories.

### **Versatile design**

Versatile design means one frame suits different seat requirements. There is no need to replace the frame, simply the seat if side access is required.

### **Carer and user friendly Height adjustment**

Using leg extension pins the height of the chair can be increased by 25mm (1") – 50mm (2") allowing chairs to be adjusted to suit changes in the users condition. It is possible to change the height of the Self Propelling models by moving the wheel from one fixing hole to another on the wheelplate, or by changing the wheel size.



### **Accessories**

The AquaMaster is available with a host of optional accessories including commode pan.



### **Alternative wheel positions**

### **Snap on, snap off seat design**

The upholstered seat is soft, comfortable and hygienic, with a sealed base to reduce the risk of bacterial growth. Easily removable for cleaning and to help maintain hygiene standards.



Gutter armrest, thoracic and head support options also available.

### **Swing away, removable height adjustable footplates**

Adjustable to suit user requirements and swing away for easy carer access/transfer.



# AquaMaster Shower and Toileting Chair Range

## Self propelled models A11

- Choice of 20" (510mm) 22" (560mm) and 24" (610mm) rear wheels



## Attendant propelled models A06

\* Shown with side access seat.



### A08

*Self Propelling model with wheels at the front. Allows greater access where space is limited.*



### A12

*Moulded easy clean seat with excellent thermal properties provides a warm feel to the skin. Fitted armrests and locking castors, for users up to 165kgs. Stainless steel model (A12S) available for swimming pool use.*





### Static model A02

*Static model with 17", 19" and 21" width options*

*\*Note: Special shower chairs can be made to order to suit individual requirements*

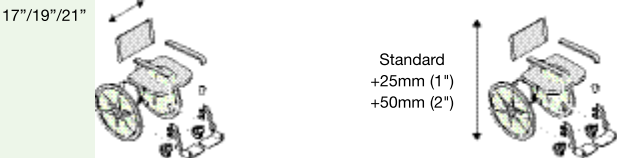
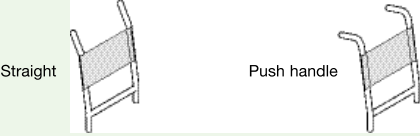
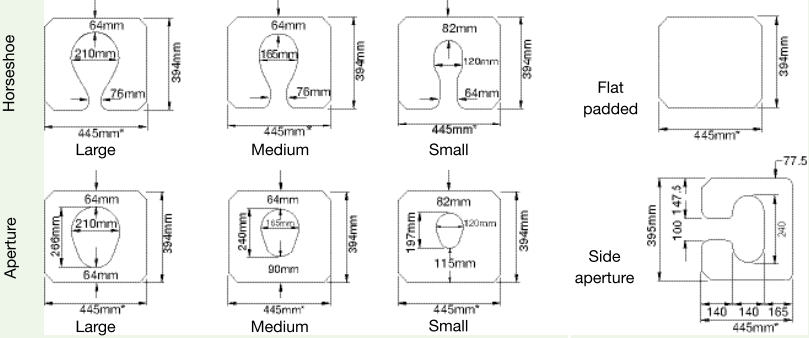
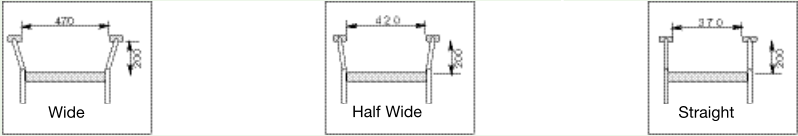
# Quick Reference Guide – Shower Chair Selector

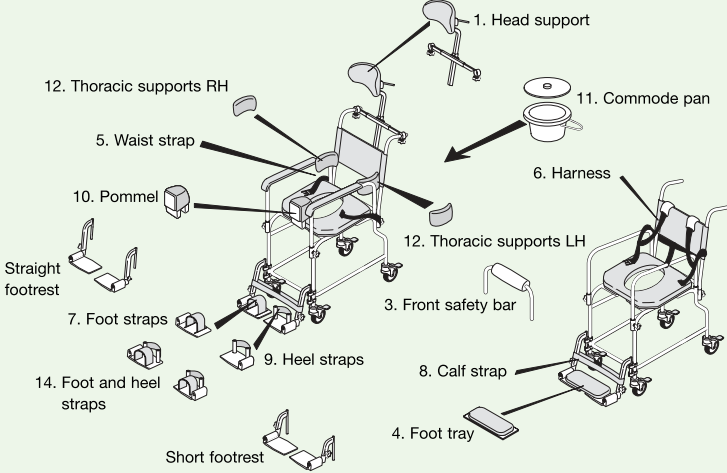
Product Description	Select from the following
<p><b>1. Chair style</b></p> <ul style="list-style-type: none"> <li>Self propelled (Large front and rear wheel options), attendant propelled or static models.</li> </ul>	
<p><b>Chair Width &amp; Height</b></p> <ul style="list-style-type: none"> <li>17"/19"/21" Wide chairs</li> <li>Height – Standard +25mm (1") +50mm (2")</li> </ul>	
<p><b>2. Backrest type</b></p> <ul style="list-style-type: none"> <li>Straight (5° recline or upright)</li> <li>Push handle (5° recline or upright)</li> </ul>	
<p><b>3. Seat Type</b></p> <ul style="list-style-type: none"> <li>17", 19" and 21"</li> <li>Padded horseshoe – small, medium, large</li> <li>Padded aperture – small, medium, large</li> <li>Padded side aperture – medium (17" and 19" chairs), large (21" chair only)</li> <li>Padded flat</li> <li>Extended seat (50/75mm) option on all seats above except side aperture</li> </ul> <p>* 19" = 460mm wide and 21" = 510mm wide.</p>	
<p><b>4. Armrest</b></p> <ul style="list-style-type: none"> <li>Wide</li> <li>Half wide</li> <li>Straight</li> </ul>	
<p><b>5. Foot rest</b></p> <ul style="list-style-type: none"> <li>Standard (18° or 90°)</li> <li>Short (18° or 90°)</li> <li>Footrest with foot straps</li> <li>Footrest with heel straps</li> <li>Footrest with foot and heel straps</li> </ul>	 <p data-bbox="691 1554 1489 1592">         Straight 90° footrest    18° footrest    Short footrest (18° or 90°)    Heel straps    Foot straps    Foot and Heel Straps       </p>
<p><b>6. Accessories</b></p> <ol style="list-style-type: none"> <li>Head support</li> <li>Gutter armrests</li> <li>Front safety bar (special arms required)</li> <li>Clip on padded foot tray</li> <li>Waist strap</li> <li>Harness</li> <li>Foot straps</li> <li>Calf strap</li> <li>Heel straps</li> <li>Pommel</li> <li>Commode pan</li> <li>Thoracic supports</li> <li>Padding for backrest – 25, 50, 75mm options (not illustrated). Please contact Technical Dept. for details</li> <li>Foot and heel support strap footrest options</li> <li>Armrest side pads – 25, 50, 75mm options (not illustrated). Please contact Technical Dept. for details</li> </ol>	

# Showering and Bathing

## AquaMaster Shower and Toileting Chair - Technical Information

### Maximum User Weight

200kgs (31 stones)

Dimensions																
Dimensions (based on 22" diameter wheel for rear propelled and 20" for front propelled wheel models)																
Code	Size	A1	A2	B	C	D1	D2	E	F	G	H	J	J1	J2	K	L
<b>Attendant</b>																
A06	17" Frame	985	965	500	260	445	415	445	390	485	260		530	635		
A06	19" Frame	985	965	500	260	445	415	480	425	520	260		530	635		
A06	21" Frame	985	965	500	260	445	415	545	490	585	260		530	635		
<b>Large front wheel self propelled</b>																
A08	17" Frame	985	965	500	260	445	415	445	360	620	260	525			315+	
A08	19" Frame	985	965	500	260	445	415	480	395	655	260	525			315+	
A08	21" Frame	985	965	500	260	445	415	545	460	720	260	525			315+	
<b>Large rear wheel self propelled</b>																
A11	17" Frame	985	965	500	260	445	415	445	385	635	260	440			190*	320
A11	19" Frame	985	965	500	260	445	415	480	435	670	260	440			190*	320
A11	21" Frame	985	965	500	260	445	415	545	485	735	260	440			190*	320
<b>Static</b>																
A02	17" Frame	985	965	500	260	445	415	445	395	465	n/a	550			315	
A02	19" Frame	985	965	500	260	445	415	480	430	500	n/a	550			315	
A02	21" Frame	985	965	500	260	445	415	545	495	565	n/a	550			315	

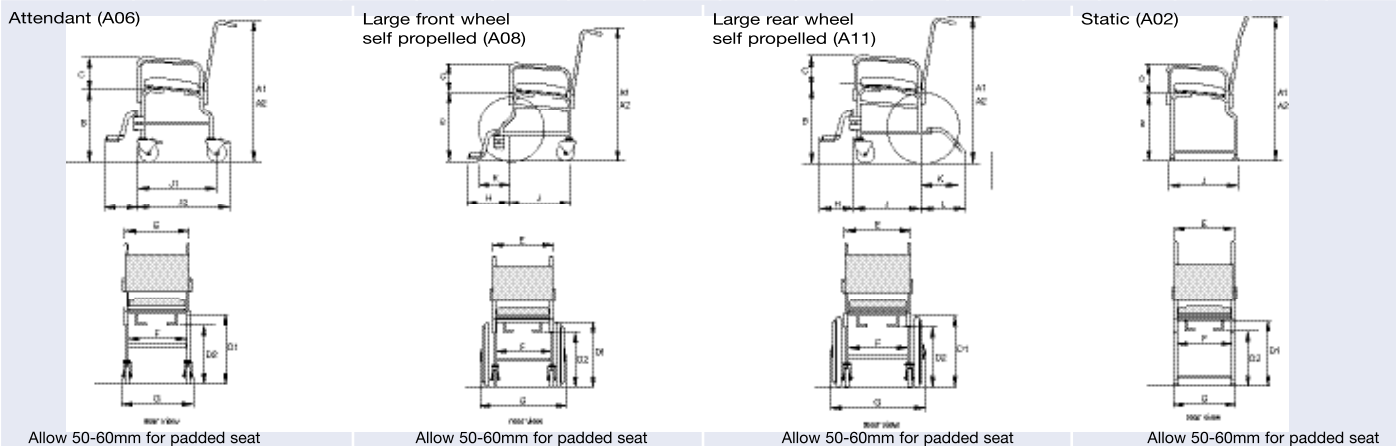

<b>A12 (not illustrated)</b>			
Seat height (top of seat)	460	Seat width	450
Overall width	530	Seat depth	370
Internal width (between armrests)	480	Push bar height	805

**Note:** Dimension A1, A2, B, D1 & D2 can decrease by up to 15mm if the maximum load is applied. The chair height can be increased by 25mm or 50mm by the use of leg extension pins.

If the chair is raised by 25mm add 25mm to A1, A2, B, D1, D2.

If the chair is raised by 50mm add 50mm to A1, A2, B, D1, D2.

### Rear wheel Self Propelled models

\* If 20" diameter wheel is used deduct 25mm from K  
\* If 24" diameter wheel is used add 25mm to K

### Front wheel Self Propelled models

+ If 22" diameter wheel is used add 25mm to K  
+ If 24" diameter wheel is used add 50mm to K

**Note:** There are three different wheel size options (20", 22" and 24") which give different seat heights and clearance dimensions. Please contact Chiltern Invadex for guidance.

\*Extended seat options available (50/75mm longer seat).

Dimensions shown are in mm for guidance only and are for unladen chairs.

A1 = Height (top of push handle), A2 = Clearance (under push handle), B = Height to top of frame, C = Height armrest pad (from frame), D1 = Height to underside of frame, D2 = Height to underside of commode sliders, E = Backrest width, F = Width (Internal), G = Width (External), H = Footrest projection, J = Length (castors frame leg), J1 = Length (castors toed in), J2 = Length (castors in line), K = Projection of front wheel (A08) & rear wheel (A11) from front, L = Projection of anti tip bar.

**Chiltern Invadex Ltd**

Chiltern House  
6 Wedgwood Road  
Bicester, Oxfordshire  
OX26 4UL

Tel: 01869 246470  
Fax: 01869 247214  
E-mail: [sales@chilterninvadex.co.uk](mailto:sales@chilterninvadex.co.uk)  
Web: [www.chilterninvadex.co.uk](http://www.chilterninvadex.co.uk)

**Overseas Enquiries**

Tel: +44 (0) 1869 365545  
Fax: +44 (0) 1869 365567  
E-mail: [export@chilterninvadex.co.uk](mailto:export@chilterninvadex.co.uk)



**SALES & SERVICE**

Tel: 01 443 3390

Email: [info@ihsltd.ie](mailto:info@ihsltd.ie)

Website: [www.ihsltd.ie](http://www.ihsltd.ie)

*Working Together With Care...*

**Chiltern Invadex Ltd**

Unit 16 Evans Business Centre  
68-74 Queen Elizabeth Avenue  
Hillington Industrial Estate  
Glasgow  
G52 4NQ

Tel: 0141 880 9986  
Fax: 0141 880 9990

**Please contact your local distributor**

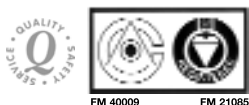
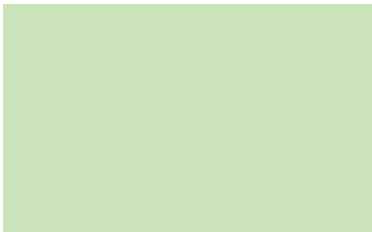

Bicester is BS EN ISO 9001 approved (FM 40009).

Bangor Northern Ireland is BS EN ISO 9002 approved (FM 21085).

Copyright © Chiltern Invadex Ltd

The design of the product shown on this brochure is vested in Chiltern Invadex Ltd and should not be copied or reproduced in anyway whatsoever without the express permission in writing of Chiltern Invadex Ltd.

As part of our commitment to new product development we reserve the right to alter specifications without prior notice.

This is an original design of Chiltern Invadex Ltd in which Design Right subsists. Dimensions are for guidance only.

Published by: Chiltern Invadex Ltd, 6 Wedgwood Road, Bicester, Oxon, OX26 4UL Registered in England No: 1182024 ISSUE 2 November 2004  
In Northern Ireland: Chiltern Invadex (NI) Ltd, 5 Balloo Way, Balloo Industrial Estate, Bangor, County Down, BT19 7QZ Registered No: NI 19958



**Other products available from  
Chiltern Invadex include:**

**Showering and Bathing**

Shower Cubicles  
Shower Accessories  
Shower Seats and Stainless Steel  
Shower Chairs  
Shower Trolleys and Stretchers  
Walk-in and Easy Transfer Baths  
Level, Easy and Step-in Showers

**Moving and Handling**

100 Series Ceiling Mounted Hoists  
200/300 Series Ceiling Mounted  
Hoists  
Wheelchairs  
Slings, Standing Jackets and  
Accessories  
Poolside Hoists  
Mobile Hoists

**Extended warranty and service  
programmes and full service  
contracts available on all hoists  
to comply with LOLER (1998)  
regulations.**

**Brochure Hotline: 0800 917 0399**



# Showering and Bathing

## **AquaMaster Shower and Toileting Chair**

Mobile showering solutions for the home,  
hospital and care environment

